

SINGAPORE

TECHNIGROUP FAR EAST PTE LTD
Corporate Headquarters:
No.30 Tuas South Street 3,
Singapore 638028
Showroom:
No.28 Tuas South Street 3,
Singapore 638027
Tel: 65 6897 7717
Fax: 65 6897 7727
Email: tfesing@technigroup.com.sg

INDONESIA

PT TECHNIGROUP INDONESIA
Menara Prima #03 - G,H,I
Jl. Lingkar Mega Kuningan Blok 6.2
Jakarta 12950, Indonesia
Tel: 62 21 5794 8010
Fax: 62 21 5794 8011
Email: info@technigroup-indonesia.co.id

MALAYSIA

TECHNIGROUP OFFICE FURNITURE SDN BHD
Office Suite 19-15-2
Level 15, UOA Centre
19 Jalan Pinang, 50450
Kuala Lumpur, Malaysia
Tel: 603 2162 6989
Fax: 603 2161 6989
Email: tof@technigroup.com.my

THAILAND

TECHNIGROUP OFFICE FURNITURE
CO LTD
399 Interchange 21 Building 23rd Floor
Sukhumvit Road, Klongtoey-Nua, Wattana
Bangkok 10110, Thailand
Tel: 66 2 259 4933
Fax: 66 2 259 4937
Email: thailand@technigroup.co.th

UNITED STATES OF AMERICA

TECHNIGROUP USA
Tel: 1 949 423 9889
Email: shiuyi@technigroupusa.com

INDIA

BANGALORE
TECHNIGROUP INTERNATIONAL PVT LTD
No.948 3rd floor, 12th main
HAL 2nd stage, Indiranagar,
Bangalore 560038, India
Tel: 91 88 8433 8844
Email: shiuyi@technigroupusa.com

MUMBAI

TECHNIGROUP INTERNATIONAL PVT LTD
316, 3rd Floor, Hubtown Viva
Western Express Highway,
Jogeshwari (East),
Mumbai 400060, India
Tel: 91 88 8433 8844
Email: shiuyi@technigroupusa.com

PUNE

TECHNIGROUP INTERNATIONAL PVT LTD
Office no. 302, Faith Center,
Sakore Nagar, Viman Nagar,
Pune 400014, India
Tel: 91 96 8991 8090
Email: shipra.tiwari@technigroup.com.sg

XE
BRIDGE x MEDIA



INSPIRATION

The all new patented XE reflects a vision that defies preconceptions and transforms the idea of a luxury furniture inspired by the bridge design. It is a blend of stunning design, intuitive technology and innovative thinking.



BRIDGE

Empowering Personality



The XE BRIDGE exemplifies new spirit of independence and confidence.



- Worksurface : Walnut Lyon Laminat (SU 3001W)
- Cantilever frame : Polish high strength steel
- Storage : Walnut Lyon Laminat (SU 3001W)
- White Melamine (101)
- Glass Top : 10mm temper glass

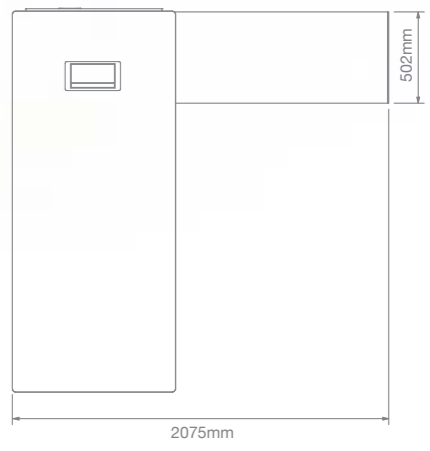
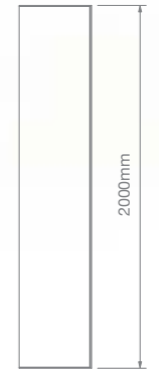
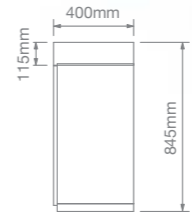
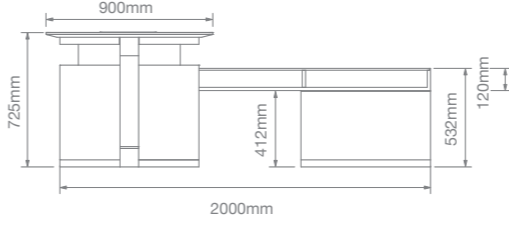
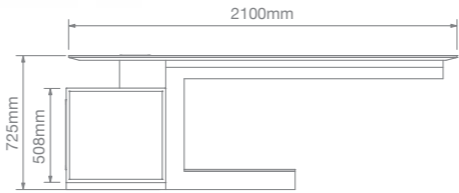



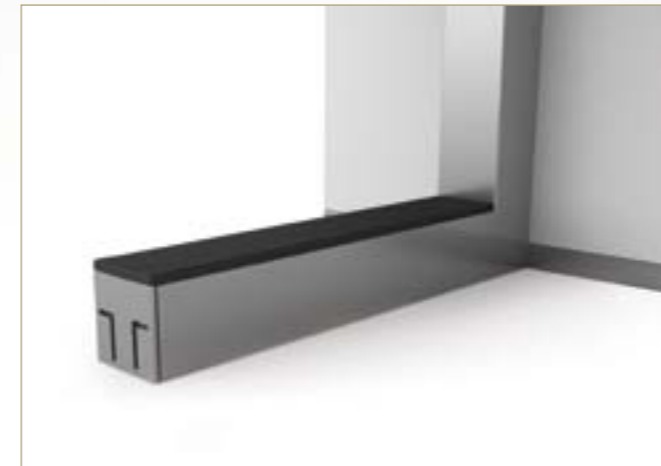

Air vent to allow warm air exhaust.

Storage compartment.

Foot rest is used to provide comfort to a person seated.

Access of cables from raised floor to beneath the work surface.

Product Code

XE BRIDGE right

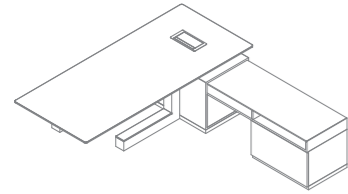

2100mm x 2075mm
XE-W2109R2004-
NBA4-ML/LM-R

XE BRIDGE left

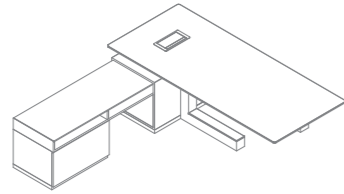

2100mm x 2075mm
XE-W2109R2004-
NBA4-ML/LM-L

XE LUX Cabinet
[4 swing doors, open shelves]

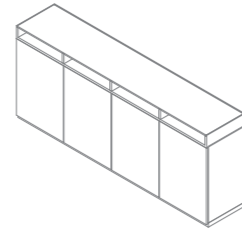

2000mm x 400mm x 845mm
XE-CD4GTOS-
200804-ML/LM

XE Wing Cabinet
[2 swing doors, 4 drawers,
2 open shelves]

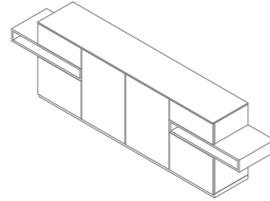

2598mm x 400mm x 750mm
XE-P-CD23D200F-
200704-ML/LM

Finishes

Laminate :

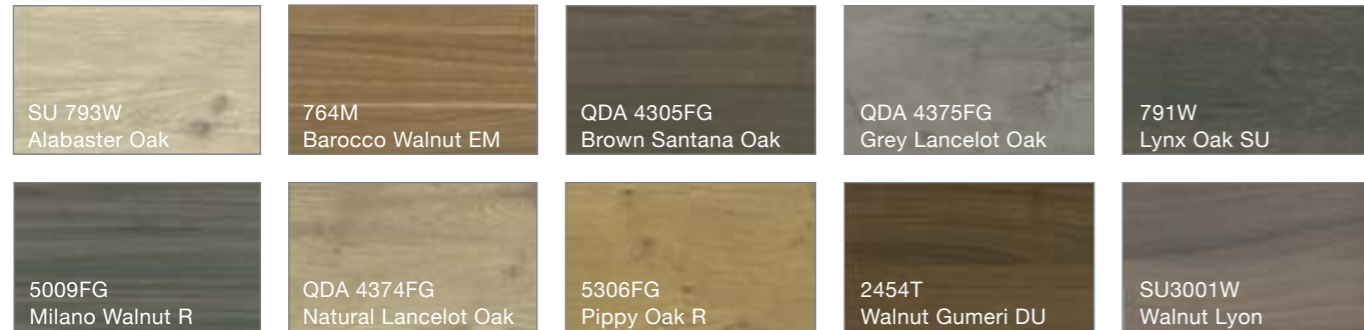

Melamine :

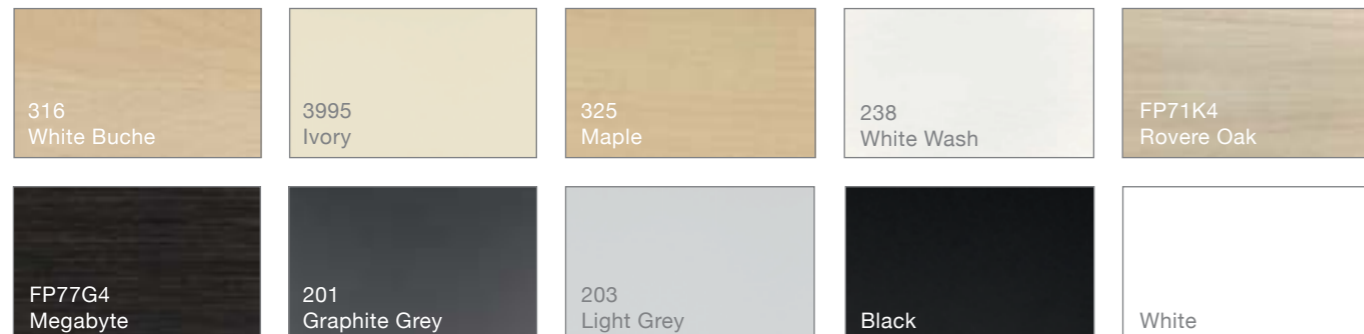

Specifications

Structural Frame :

Made from steel construction material AISI steel grades. I-shape cross section have high second moments of area, which allow them to be very stiff in respect to their cross-sectional area.

Steel Component :

All steel components are treated and power to a minimum 50 microns. (with environment friendly materials)

Worktops Finishes :

Standard worktop finishes are available in melamine or laminate.

Worktops :

25 mm thick European E1 grade melamine / Laminate Board with 3mm thick Impact resultant PVC edging. Finishes are scratch and abrasion resistant with a minimum density of 620 kg/mc+/- 5%.

Glass :

All glass used are 10mm temper glass.



MEDIA

Dynamic collaboration



XE MEDIA DT

With XE MEDIA, it creates a collaborative workspace which allows people to access and share information quickly and effectively.



Netbox-axial allowing the cable to travel to and fro from desktop.

Dynamic collaboration solutions for

- Education spaces
- Conference spaces
- Lounge spaces
- Meeting spaces
- Hospital spaces
- Research spaces



XE MEDIA is available in

- XE MEDIA DT [Desk Height]
- XE MEDIA ST [Sofa Height]
- XE MEDIA BT [Bar Height]

Worksurface : White Melamine (101)
Cantilever frame : Polish high strength steel
Storage : Dark Grey Melamine (0201)
TV Carcass : Steel

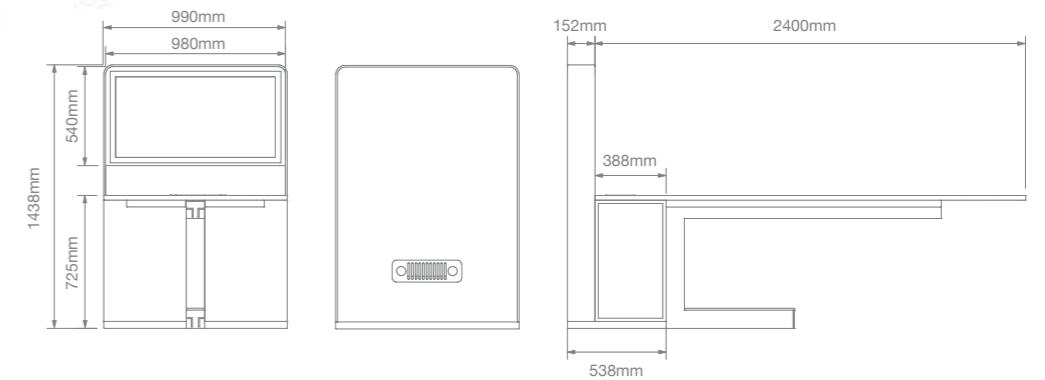

XE MEDIA White Board enhances people collaboration.



XE MEDIA ST

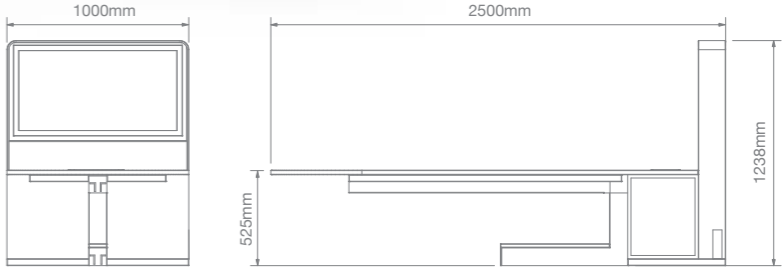

XE MEDIA ST

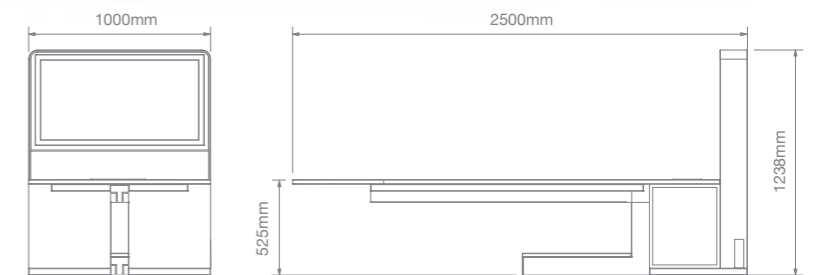

XE MEDIA BT

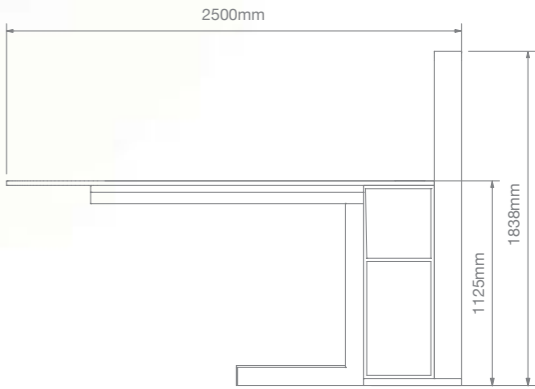
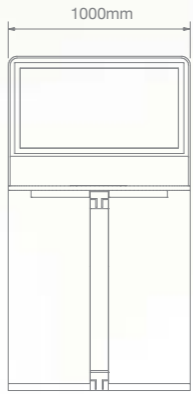

Product Code

XE MEDIA DT
[Desk Height table]

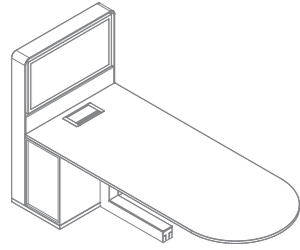

2500mm x 1000 x 730mm
Table HT = 730mm
XE-MEDIA251007DT-ML/LM

XE MEDIA ST
[Sofa Height table]

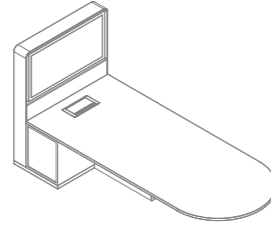

2500mm x 1000 x 525mm
Table HT = 525mm
XE-MEDIA251005ST-ML/LM

XE MEDIA BT
[Bar Height table]

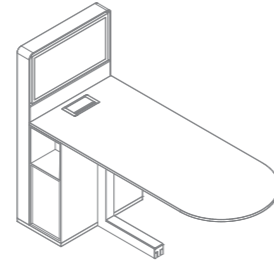

2500mm x 1000 x 1125mm
Table HT = 1125mm
XE-MEDIA251018BT-ML/LM

Finishes

Laminate :

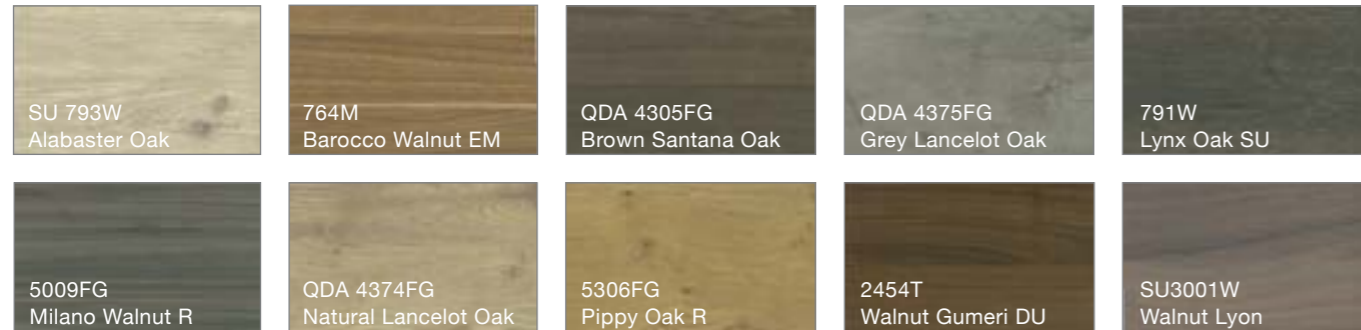

Melamine :

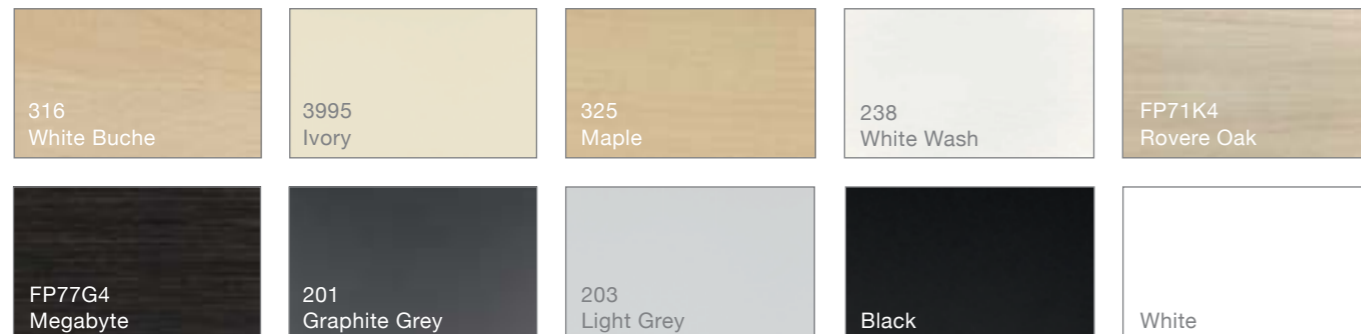

Specifications

Structural Frame :

Made from steel construction material AISI steel grades. I-shape cross section have high second moments of area, which allow them to be very stiff in respect to their cross-sectional area.

Steel Component :

All steel components are treated and powder coated to a minimum 50 microns. (with environment friendly materials)

Worktops Finishes :

Standard worktop finishes are available in melamine or laminate.

Worktops :

25 mm thick European E1 grade melamine / Laminate Board with 3mm thick Impact resistant PVC edging. Finishes are scratch and abrasion resistant with a minimum density of 620 kg/mc+/- 5%.

Magnetic White Board :

A metal - infused sheet which is used over MDF (medium density fiberboard) on both sides with 3mm thick impact resistant vinyl edge. Steel is magnetic and allows the use of magnets.

